

## COMPRESSION FITTINGS - PERFORMANCE SERIES

### ACCESORIOS DE COMPRESIÓN - SERIE PERFORMANCE



Sizes	D16 - D110 (DN10-DN100)	
Standards	Compression - Metric, IPS, CTS Threaded - BSP, NPT	
Working pressure	@ 20°C (73°F) D16 - D63 (3/8" - 2"): PN 16 (240 psi) D75 - D110 (2 1/2" - 4"): PN 10 (150 psi)	
Materials	O-rings: NBR	
Characteristics	<ul style="list-style-type: none"> <li>• PP Compression Fittings for PE pressure piping applications.</li> <li>• Injection moulding.</li> <li>• Perfect sealing in all conditions.</li> <li>• Fast &amp; reliable connections.</li> <li>• Tested and approved by the main testing institutes worldwide.</li> <li>• Applications: irrigation, industry, water distribution, swimming pools, etc.</li> <li>• Also approved for use with PVC flexible hose.</li> </ul>	<ul style="list-style-type: none"> <li>• Accesorios en PP para canalizaciones de PE a presión.</li> <li>• Moldeo por inyección.</li> <li>• Estanqueidad perfecta en todas las condiciones de trabajo.</li> <li>• Conexiones rápidas y fiables.</li> <li>• Analizados y aprobados por los institutos más importantes a nivel mundial.</li> <li>• Aplicaciones: riego, industria, tratamiento de aguas, piscinas, etc.</li> <li>• También compatibles para uso con tubería de PVC flexible.</li> </ul>
Certifications	APROBATA TECHNICZNA / ISO 14236-2000 / AVIZ TECHNIC / GOST-R / CSA / NSF	

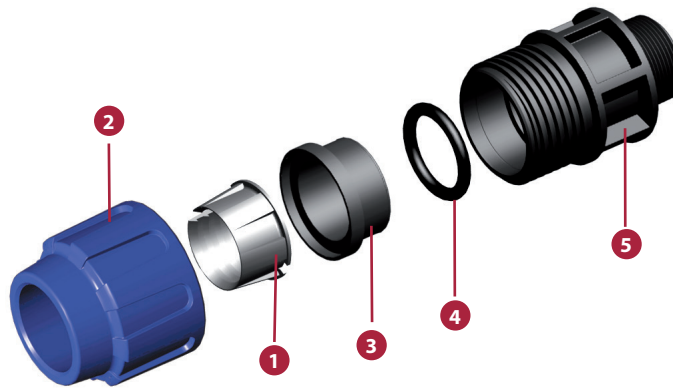
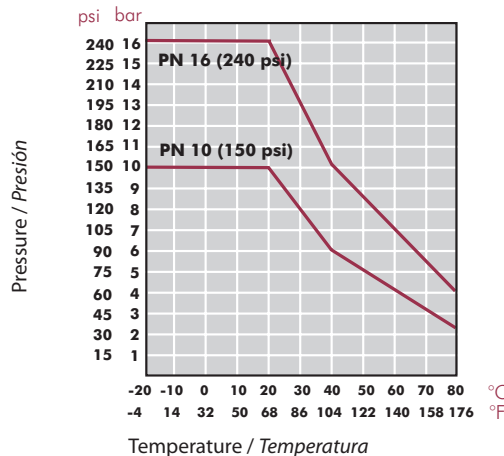

FIG.	Parts	Despiece	Material
1	Split ring	Cono de fijación	POM
2	Nut	Tuerca	PP
3	Insert	Casquillo prensa	PP
4	O-ring	Junta tórica	NBR 70 (*)
5	Body	Cuerpo	PP

(\*) NBR: potable water rubber  
NBR: junta agua potable

**PRESSURE / TEMPERATURE GRAPH**  
**DIAGRAMA PRESIÓN / TEMPERATURA**



Life: 25 years  
Hydrostatic maximum pressure a component may withstand in continuous service (without overpressure)

Vida útil: 25 años  
Presión hidrostática máxima que un componente es capaz de soportar en servicio continuo (sin sobrepresión)

Performance of plastic materials in contact with non-dangerous fluids.  
The durability of those parts exposed to fluids will depend on the working conditions

Valores indicativos para materiales en contacto con fluidos no peligrosos.  
La vida en las partes expuestas a los fluidos dependerá de las condiciones de trabajo.

- Dimensions and characteristics according to:
  - EN 712 / 713 / 715 / 911
  - ISO 3458 / 3459 / 3501 / 3503
  - ISO 14236
  - DIN 8076 (Performance Series)
  - UNI 9561 (Performance Series)
- To be installed on PE pipes (PE-HD, PE-LD, PE40, PE63, PE80, PE100) conforming to:
  - EN 12201
  - ISO 3607 / 14236
  - DIN 8072 / 8074
  - UNI 10910
- Threads (BSP) manufactured according to:
  - ISO 7
  - DIN 2999
  - BS 21
  - UNI 338

- Dimensiones y características según las normas:
  - EN 712 / 713 / 715 / 911
  - ISO 3458 / 3459 / 3501 / 3503
  - ISO 14236
  - DIN 8076 (Serie Performance)
  - UNI 9561 (Serie Performance)
- Para instalar en tubería de PE (PEAD, PEBD, PE40, PE63, PE80, PE100) conforme a las normas:
  - EN 12201
  - ISO 3607 / 14236
  - DIN 8072 / 8074
  - UNI 10910
- Roscas (BSP) fabricadas según el standard:
  - ISO 7
  - DIN 2999
  - BS 21
  - UNI 338

**ELBOWS**  
**CODOS**
**PP-P. 01. CP - PP COMPRESSION ELBOW**
**90° elbow**

• Comp x Comp

**Codo 90°**

• Comp x Comp

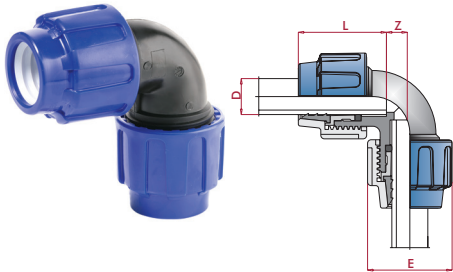

D	DN	PN	REF.	CODE
16 x 16	10	16	11 01 016	<b>01469</b>
20 x 20	15	16	11 01 020	<b>01470</b>
25 x 25	20	16	11 01 025	<b>01471</b>
32 x 32	25	16	11 01 032	<b>01472</b>
40 x 40	32	16	11 01 040	<b>01473</b>
50 x 50	40	16	11 01 050	<b>01474</b>
63 x 63	50	16	11 01 063	<b>01475</b>
75 x 75	65	10	11 01 075	<b>01476</b>
90 x 90	80	10	11 01 090	<b>17898</b>
110 x 110	100	10	11 01 110	<b>17899</b>

L	Z	E
49	13	44
49	13	44
58	16	56
81	18	66
92	24	80
108	28	94
125	32	114
140	37	130
156	53	153
176	63	181

**PP-P. 01. CPFT - PP COMPRESSION ELBOW**
**90° elbow**

• Comp x BSP female thread

**Codo 90°**

• Comp x rosca hembra BSP

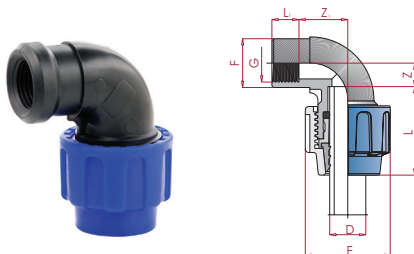

D x G	DN	PN	REF.	CODE
16 x 3/8"	10 x 10	10	11 01 416	<b>01478</b>
16 x 1/2"	10 x 15	10	11 01 417	<b>09145</b>
20 x 1/2"	15 x 15	10	11 01 420	<b>01479</b>
20 x 3/4"	15 x 20	10	11 01 421	<b>01480</b>
25 x 1/2"	20 x 15	10	11 01 424	<b>07350</b>
25 x 3/4"	20 x 20	10	11 01 425	<b>01481</b>
32 x 1/2"	25 x 15	10	11 01 430	<b>09710</b>
32 x 3/4"	25 x 20	10	11 01 431	<b>01482</b>
32 x 1"	25 x 25	10	11 01 432	<b>01483</b>
40 x 3/4"	32 x 20	10	11 01 438	<b>33488</b>
40 x 1"	32 x 25	10	11 01 439	<b>33489</b>
40 x 1 1/4"	32 x 32	10	11 01 440	<b>01485</b>
40 x 1 1/2"	32 x 40	10	11 01 441	<b>01486</b>
50 x 1 1/4"	40 x 32	10	11 01 449	<b>34577</b>
50 x 1 1/2"	40 x 40	10	11 01 450	<b>01487</b>
50 x 2"	40 x 50	10	11 01 451	<b>01488</b>
63 x 1 1/4"	50 x 32	10	11 01 461	<b>34579</b>
63 x 1 1/2"	50 x 40	10	11 01 462	<b>33132</b>
63 x 2"	50 x 50	10	11 01 463	<b>01489</b>
75 x 2"	65 x 50	10	11 01 474	<b>01490</b>
75 x 2 1/2"	65 x 65	10	11 01 475	<b>01491</b>
90 x 3"	80 x 80	10	11 01 490	<b>17900</b>
90 x 4"	100 x 100	10	11 01 491	<b>17901</b>
110 x 4"	110 x 110	10	11 01 510	<b>17902</b>

L	L <sub>1</sub>	Z	Z <sub>1</sub>	E	F
49	15	13	22	44	27
49	16	13	22	44	27
49	16	13	26	44	27
49	19	13	26	44	34
58	19	16	31	56	34
58	19	16	31	56	34
81	16	18	43	66	27
81	19	18	43	66	34
81	22	18	43	66	41
92	19	24	48	80	34
92	24	24	46	80	41
92	24	24	54	80	52
92	24	24	54	80	61
108	24	28	58	94	52
108	24	28	58	94	61
108	28	28	58	94	76
125	24	32	70	114	52
125	28	32	68	114	58
125	28	32	67	114	76
140	28	41	83	130	76
140	33	41	83	130	88
156	35	53	55	153	109
156	36	53	89	153	132
176	38	63	63	181	135

**PP-P. 01. CPMT - PP COMPRESSION ELBOW**

**90° elbow**

- Comp x BSP male thread

**Codo 90°**

- Comp x rosca macho BSP

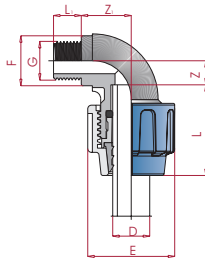

D x G	DN	PN	REF.	CODE
16 x 3/8"	10 x 10	10	11 01 616	01493
16 x 1/2"	10 x 15	10	11 01 617	09146
20 x 1/2"	15 x 15	10	11 01 620	01494
20 x 3/4"	15 x 20	10	11 01 621	01495
25 x 1/2"	20 x 15	10	11 01 624	01496
25 x 3/4"	20 x 20	10	11 01 625	01497
32 x 1/2"	25 x 15	10	11 01 630	32055
32 x 3/4"	25 x 20	10	11 01 631	32056
32 x 1"	25 x 25	10	11 01 632	01498
40 x 1/4"	32 x 32	10	11 01 640	01499
40 x 1/2"	32 x 40	10	11 01 641	01484
50 x 1/4"	40 x 32	10	11 01 649	01500
50 x 1/2"	40 x 40	10	11 01 650	01501
50 x 2"	40 x 50	10	11 01 651	01502
63 x 1/4"	50 x 32	10	11 01 661	34580
63 x 1/2"	50 x 40	10	11 01 662	34581
63 x 2"	50 x 50	10	11 01 663	01503
75 x 2 1/2"	65 x 65	10	11 01 675	01504
90 x 3"	80 x 80	10	11 01 690	17903
90 x 4"	100 x 100	10	11 01 691	17904
110 x 4"	110 x 110	10	11 01 710	17905

L	L <sub>1</sub>	Z	Z <sub>1</sub>	E	F
49	13	13	27	44	27
49	13	13	27	44	27
49	14	13	26	44	27
49	16	13	26	44	30
58	14	16	34	56	27
58	16	16	34	56	30
81	14	18	34	66	27
81	16	18	34	66	30
81	19	18	45	66	36
92	21	24	59	80	48
92	21	24	59	80	52
108	21	28	68	94	48
108	21	28	68	94	52
108	26	28	68	94	66
125	24	32	71	114	48
125	24	32	71	114	52
125	26	32	78	114	66
140	30	41	83	130	82
156	35	53	77	153	113
156	39	53	77	153	113
176	40	63	90	181	135

**PP-P. 01. CPW - PP COMPRESSION ELBOW**

**90° elbow**

- Comp x BSP female thread - wall

**Codo 90°**

- De pared - Comp x rosca hembra BSP

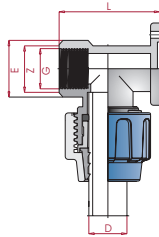

D x G	DN	PN	REF.	CODE
25 x 3/4"	56	10	11 01 225	11723

L	Z	E
65	32	36

**PP-P. 01. CPWR - PP COMPRESSION ELBOW**

**90° reinforced elbow**

- Comp x BSP female thread - wall
- Reinforcement in stainless steel

**Codo 90° reforzado**

- De pared - Comp x rosca hembra BSP
- Refuerzo en acero inoxidable

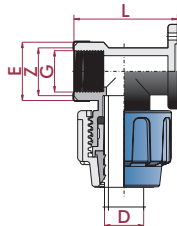

D x G	DN	PN	REF.	CODE
25 x 3/4"	56	10	11 01 325	15778

L	Z	E
65	32	36

**TEES**  
**TÉS**

**PP-P. 03. CP - PP COMPRESSION TEE**

**90° tee**

- Comp x Comp x Comp

**Té 90°**

- Comp x Comp x Comp

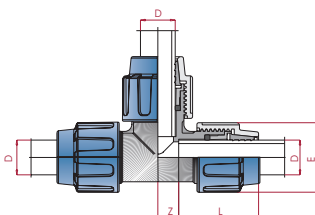

D	DN	PN	REF.	CODE
16 x 16 x 16	10	16	11 03 016	01506
20 x 20 x 20	15	16	11 03 020	01507
25 x 25 x 25	20	16	11 03 025	01508
32 x 32 x 32	25	16	11 03 032	01509
40 x 40 x 40	32	16	11 03 040	01510
50 x 50 x 50	40	16	11 03 050	01511
63 x 63 x 63	50	16	11 03 063	01512
75 x 75 x 75	65	10	11 03 075	01513
90 x 90 x 90	80	10	11 03 090	17906
110 x 110 x 110	100	10	11 03 110	17907

L	Z	E
49	13	44
49	13	44
58	16	56
81	18	66
92	24	80
108	28	94
125	32	114
140	41	130
156	53	153
176	63	181

**PP-P. 03. CPFT - PP COMPRESSION TEE**
**90° tee**

• Comp x BSP female thread x Comp

**Té 90°**

• Comp x rosca hembra BSP x Comp

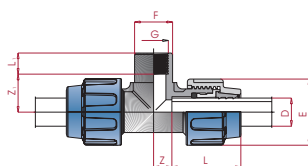

D x G x D	DN	PN	REF.	CODE
16 x 3/8" x 16	10 x 10	10	11 03 416	<b>01523</b>
16 x 1/2" x 16	10 x 15	10	11 03 417	<b>09147</b>
20 x 1/2" x 20	15 x 15	10	11 03 420	<b>01524</b>
20 x 3/4" x 20	15 x 20	10	11 03 421	<b>01525</b>
25 x 1/2" x 25	20 x 15	10	11 03 424	<b>01526</b>
25 x 3/4" x 25	20 x 20	10	11 03 425	<b>01527</b>
25 x 1" x 25	25 x 20	10	11 03 426	<b>34227</b>
32 x 1/2" x 32	25 x 15	10	11 03 430	<b>01528</b>
32 x 3/4" x 32	25 x 20	10	11 03 431	<b>03337</b>
32 x 1" x 32	25 x 25	10	11 03 432	<b>01529</b>
40 x 1 1/4" x 40	32 x 32	10	11 03 440	<b>01530</b>
50 x 1" x 50	40 x 25	10	11 03 448	<b>33129</b>
50 x 1 1/2" x 50	40 x 40	10	11 03 450	<b>01531</b>
50 x 2" x 50	40 x 50	10	11 03 451	<b>01532</b>
63 x 1" x 63	50 x 25	10	11 03 460	<b>33130</b>
63 x 1 1/2" x 63	50 x 40	10	11 03 462	<b>33131</b>
63 x 2" x 63	50 x 50	10	11 03 463	<b>01533</b>
75 x 2 1/2" x 75	65 x 65	10	11 03 475	<b>01534</b>
90 x 3" x 90	80 x 80	10	11 03 490	<b>17910</b>
110 x 3" x 110	100 x 100	10	11 03 509	<b>17911</b>
110 x 4" x 110	110 x 110	10	11 03 510	<b>17912</b>

L	L <sub>1</sub>	Z	Z <sub>1</sub>	E	F
49	15	13	22	44	27
49	16	13	22	44	27
49	16	13	26	44	27
49	19	13	26	44	34
58	16	16	31	56	27
58	19	19	31	56	34
58	24	19	34	56	47
81	16	18	43	66	27
81	19	18	43	66	34
81	22	18	43	66	41
92	24	24	54	80	52
108	24	28	50	94	42
108	24	28	58	94	61
140	28	28	58	94	76
125	24	32	62	114	42
125	28	32	67	114	58
125	28	32	67	114	76
140	33	41	83	130	88
156	35	53	55	153	109
176	36	63	69	181	114
176	40	63	61	181	114

**PP-P. 03. CPMT - PP COMPRESSION TEE**
**90° tee**

• Comp x BSP male thread x Comp

**Té 90°**

• Comp x rosca macho BSP x Comp

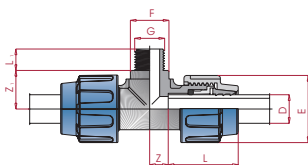

D x G x D	DN	PN	REF.	CODE
16 x 3/8" x 16	10 x 10	10	11 03 616	<b>01536</b>
16 x 1/2" x 16	10 x 15	10	11 03 617	<b>09148</b>
20 x 1/2" x 20	15 x 15	10	11 03 620	<b>01537</b>
20 x 3/4" x 20	15 x 20	10	11 03 621	<b>01538</b>
25 x 1/2" x 25	20 x 15	10	11 03 624	<b>01539</b>
25 x 3/4" x 25	20 x 20	10	11 03 625	<b>01540</b>
32 x 1/2" x 32	25 x 15	10	11 03 630	<b>01541</b>
32 x 1" x 32	25 x 25	10	11 03 632	<b>01542</b>
40 x 1 1/4" x 40	32 x 32	10	11 03 640	<b>01543</b>
40 x 1 1/2" x 40	32 x 40	10	11 03 641	<b>03338</b>
50 x 1 1/2" x 50	40 x 40	10	11 03 650	<b>01544</b>
63 x 2" x 63	50 x 50	10	11 03 663	<b>01545</b>
75 x 2 1/2" x 75	65 x 65	10	11 03 675	<b>01546</b>
90 x 3" x 90	80 x 80	10	11 03 690	<b>17913</b>
90 x 4" x 90	80 x 110	10	11 03 691	<b>17914</b>
110 x 4" x 110	110 x 110	10	11 03 710	<b>17915</b>

L	L <sub>1</sub>	Z	Z <sub>1</sub>	E	F
49	13	13	27	44	27
49	14	13	26	44	27
49	14	13	26	44	27
49	16	13	26	44	30
58	14	16	34	56	27
58	16	16	34	56	30
81	14	18	45	66	27
81	19	18	45	66	36
92	21	24	59	80	48
92	21	24	59	80	52
108	21	28	68	94	52
125	26	32	78	114	66
140	30	41	83	130	82
156	35	53	77	153	117
156	39	53	77	153	117
176	40	63	90	181	142

**PP-P. 04. CPR - PP COMPRESSION TEE**
**90° reducing tee**

• Comp x Comp x Comp

**Té reducida 90°**

• Comp x Comp x Comp

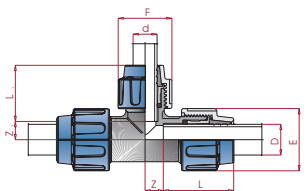

D x d x D	DN	PN	REF.	CODE
20 x 16 x 20	10	16	11 04 020	<b>01515</b>
25 x 20 x 25	15	16	11 04 025	<b>01516</b>
32 x 25 x 32	20	16	11 04 032	<b>01517</b>
40 x 32 x 40	25	16	11 04 040	<b>01518</b>
50 x 32 x 50	25	16	11 04 049	<b>33487</b>
50 x 40 x 50	32	16	11 04 050	<b>01519</b>
63 x 50 x 63	40	16	11 04 063	<b>01520</b>
75 x 63 x 75	50	10	11 04 075	<b>01521</b>
90 x 75 x 90	65	10	11 04 090	<b>17908</b>
110 x 90 x 110	80	10	11 04 110	<b>17909</b>

L	L <sub>1</sub>	Z	Z <sub>1</sub>	E	F
49	49	13	13	44	44
58	49	16	13	56	44
81	58	18	16	66	56
92	81	24	18	80	66
108	86	28	28	94	66
108	92	28	24	94	80
125	108	32	28	114	94
140	125	41	32	130	114
156	131	53	58	153	130
176	156	63	68	181	153

### PP-P. 08. CPA - PP COMPRESSION TEE

**90° enlarging tee**

• Comp x Comp x Comp

**Té ampliada 90°**

• Comp x Comp x Comp

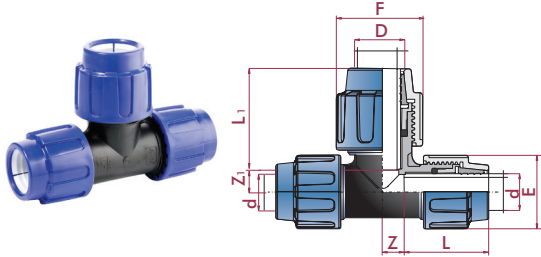

d x D x d	DN	PN	REF.	CODE
20 x 25 x 20	15 x 20	16	11 08 020	<b>33891</b>

L	L <sub>1</sub>	Z	Z <sub>1</sub>	E	F
49	58	16	13	44	56

## COUPLINGS ENLACES

### PP-P. 05. CP - PP COMPRESSION COUPLING

**Coupling**

• Comp x Comp

**Manguito**

• Comp x Comp

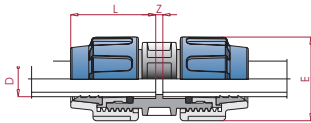

D	DN	PN	REF.	CODE
16 x 16	10	16	11 05 016	<b>01548</b>
20 x 20	15	16	11 05 020	<b>01549</b>
25 x 25	20	16	11 05 025	<b>01550</b>
32 x 32	25	16	11 05 032	<b>01551</b>
40 x 40	32	16	11 05 040	<b>01552</b>
50 x 50	40	16	11 05 050	<b>01553</b>
63 x 63	50	16	11 05 063	<b>01554</b>
75 x 75	65	10	11 05 075	<b>01555</b>
90 x 90	80	10	11 05 090	<b>17916</b>
110 x 110	100	10	11 05 110	<b>17917</b>

L	Z	E
49	4	44
49	4	44
58	4	56
81	4	66
92	5	80
108	8	94
125	8	114
140	10	130
148	10	153
167	12	181

### PP-P. 05. CPFT - PP COMPRESSION ADAPTOR

**Adaptor**

• Comp x BSP female thread

**Enlace**

• Comp x rosca hembra BSP

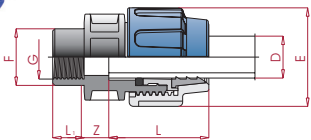

D x G	DN	PN	REF.	CODE
16 x 3/8"	10 x 10	10	11 05 416	<b>01565</b>
16 x 1/2"	10 x 15	10	11 05 417	<b>07349</b>
20 x 1/2"	15 x 15	10	11 05 420	<b>01566</b>
20 x 3/4"	15 x 20	10	11 05 421	<b>01567</b>
25 x 1/2"	20 x 15	10	11 05 424	<b>01568</b>
25 x 3/4"	20 x 20	10	11 05 425	<b>01569</b>
25 x 1"	20 x 25	10	11 05 426	<b>01570</b>
32 x 3/4"	25 x 20	10	11 05 431	<b>01571</b>
32 x 1"	25 x 25	10	11 05 432	<b>01572</b>
40 x 1"	32 x 25	10	11 05 439	<b>01573</b>
40 x 1 1/4"	32 x 32	10	11 05 440	<b>01574</b>
50 x 1 1/4"	40 x 32	10	11 05 449	<b>01575</b>
50 x 1 1/2"	40 x 40	10	11 05 450	<b>01576</b>
50 x 2"	40 x 50	10	11 05 451	<b>01577</b>
63 x 1 1/2"	50 x 40	10	11 05 462	<b>34582</b>
63 x 2"	50 x 50	10	11 05 463	<b>01578</b>
75 x 2"	65 x 50	10	11 05 474	<b>01579</b>
75 x 2 1/2"	65 x 65	10	11 05 475	<b>01580</b>
75 x 3"	65 x 80	10	11 05 476	<b>20786</b>
90 x 2"	80 x 50	10	11 05 488	<b>17921</b>
90 x 2 1/2"	80 x 65	10	11 05 489	<b>17922</b>
90 x 3"	80 x 80	10	11 05 490	<b>17923</b>
90 x 4"	80 x 100	10	11 05 491	<b>17924</b>
110 x 2"	100 x 50	10	11 05 508	<b>17925</b>
110 x 3"	100 x 80	10	11 05 509	<b>17926</b>
110 x 4"	100 x 100	10	11 05 510	<b>17927</b>

L	L <sub>1</sub>	Z	E	F
49	15	11	44	27
49	16	11	44	27
49	16	11	44	27
49	19	11	44	34
58	16	12	56	27
58	19	12	56	34
53	22	12	56	41
81	19	15	66	34
81	22	15	66	41
92	22	17	80	41
92	24	17	80	52
108	24	17	94	52
108	24	17	94	61
108	28	17	94	76
125	28	19	114	61
125	28	19	114	76
140	28	39	130	76
140	33	39	130	88
140	33	39	130	113
148	32	8	153	87
148	32	10	153	106
148	34	8	153	113
148	38	29	153	135
167	32	14	181	87
167	34	12	181	119
167	38	8	181	144

**PP-P. 05. CPMT - PP COMPRESSION ADAPTOR**
**Adaptor**

• Comp x BSP male thread

**Enlace**

• Comp x rosca macho BSP

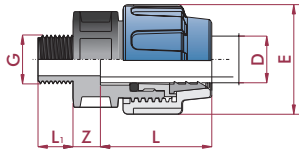

D x G	DN	PN	REF.	CODE	L	L <sub>1</sub>	Z	E
16 x 3/8"	10 x 10	10	11 05 616	<b>01582</b>	49	13	14	44
16 x 1/2"	10 x 15	10	11 05 617	<b>07348</b>	49	14	14	44
16 x 3/4"	10 x 20	10	11 05 618	<b>31921</b>	49	16	14	44
20 x 1/2"	15 x 15	10	11 05 620	<b>01583</b>	49	14	14	44
20 x 3/4"	15 x 20	10	11 05 621	<b>01584</b>	49	16	14	44
20 x 1"	15 x 25	10	11 05 622	<b>01585</b>	49	19	14	44
25 x 1/2"	20 x 15	10	11 05 624	<b>01586</b>	58	14	15	56
25 x 3/4"	20 x 20	10	11 05 625	<b>01587</b>	58	16	15	56
25 x 1"	20 x 25	10	11 05 626	<b>01588</b>	58	19	15	56
32 x 3/4"	25 x 20	10	11 05 631	<b>01589</b>	81	16	16	66
32 x 1"	25 x 25	10	11 05 632	<b>01590</b>	81	19	16	66
32 x 1 1/4"	25 x 32	10	11 05 633	<b>06154</b>	81	21	16	66
40 x 1"	32 x 25	10	11 05 639	<b>33127</b>	92	21	22	80
40 x 1 1/4"	32 x 32	10	11 05 640	<b>01591</b>	92	21	22	80
40 x 1 1/2"	32 x 40	10	11 05 641	<b>01592</b>	92	21	22	80
50 x 1"	40 x 25	10	11 05 648	<b>33128</b>	92	21	22	94
50 x 1 1/4"	40 x 32	10	11 05 649	<b>06155</b>	108	21	23	94
50 x 1 1/2"	40 x 40	10	11 05 650	<b>01593</b>	108	21	23	94
50 x 2"	40 x 50	10	11 05 651	<b>01594</b>	108	26	23	94
63 x 1 1/2"	50 x 40	10	11 05 662	<b>01595</b>	125	21	25	114
63 x 2"	50 x 50	10	11 05 663	<b>01596</b>	125	26	25	114
75 x 2"	65 x 50	10	11 05 674	<b>01597</b>	140	26	39	130
75 x 2 1/2"	65 x 65	10	11 05 675	<b>01598</b>	140	30	39	130
75 x 3"	65 x 80	10	11 05 676	<b>09711</b>	140	33	39	130
90 x 2"	80 x 50	10	11 05 688	<b>17928</b>	148	30	30,5	153
90 x 2 1/2"	80 x 65	10	11 05 689	<b>17929</b>	148	32	30	153
90 x 3"	80 x 80	10	11 05 690	<b>17930</b>	148	34	30	153
90 x 4"	80 x 100	10	11 05 691	<b>17931</b>	148	39	29	153
110 x 2"	100 x 50	10	11 05 708	<b>17932</b>	167	30	31	181
110 x 3"	100 x 80	10	11 05 709	<b>17933</b>	167	35	31	181
110 x 4"	100 x 100	10	11 05 710	<b>17934</b>	167	38	31	181

**PP-P. 06. CPR - PP COMPRESSION REDUCTION**
**Reducing coupling**

• Comp x Comp

**Manguito reducido**

• Comp x Comp

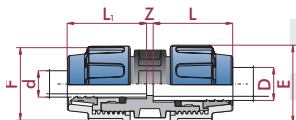
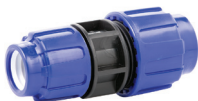

D x d	DN	PN	REF.	CODE	L	L <sub>1</sub>	Z	E	F
20 x 16	10	16	11 06 020	<b>01557</b>	49	49	4	44	44
25 x 20	15	16	11 06 025	<b>01558</b>	58	49	4	56	44
32 x 20	15	16	11 06 031	<b>33490</b>	81	49	5	66	44
32 x 25	20	16	11 06 032	<b>01559</b>	81	58	4	66	56
40 x 25	20	16	11 06 039	<b>34576</b>	92	58	12	80	56
40 x 32	25	16	11 06 040	<b>01560</b>	92	81	4	80	66
50 x 32	25	16	11 06 049	<b>27994</b>	108	81	5	94	66
50 x 40	32	16	11 06 050	<b>01561</b>	108	92	5	94	80
63 x 50	40	16	11 06 063	<b>01562</b>	125	108	8	114	94
75 x 63	50	10	11 06 075	<b>01563</b>	140	125	15	130	114
90 x 63	65	10	11 06 089	<b>17918</b>	148	116	6	153	114
90 x 75	80	10	11 06 090	<b>17919</b>	148	141	6	153	130
110 x 90	100	10	11 06 110	<b>17920</b>	167	148	15	181	153

**CAPS  
TAPONES**
**PP-P. 07. CP - PP COMPRESSION CAP**
**Cap**

• Comp

**Tapón**

• Comp

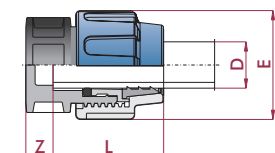

D	DN	PN	REF.	CODE	L	Z	E
16	10	16	11 07 016	<b>01600</b>	49	14	44
20	15	16	11 07 020	<b>01601</b>	49	14	44
25	20	16	11 07 025	<b>01602</b>	58	15	56
32	25	16	11 07 032	<b>01603</b>	81	16	66
40	32	16	11 07 040	<b>01604</b>	92	22	80
50	40	16	11 07 050	<b>01605</b>	108	23	94
63	50	16	11 07 063	<b>01606</b>	125	25	114
75	65	10	11 07 075	<b>01607</b>	140	40	130
90	80	10	11 07 090	<b>17935</b>	148	28	153
110	100	10	11 07 110	<b>17936</b>	167	31	181

**ELBOWS**  
**CODOS**

**PP-P. 01. CP - PP COMPRESSION ELBOW**

- 90° elbow**  
• Comp x Comp  
• CTS Standard

- Codo 90°**  
• Comp x Comp  
• CTS Standard

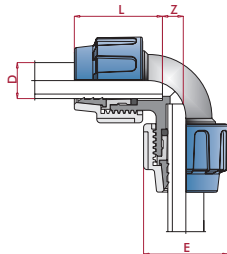

D	PN	REF.	CODE
¾"	16	33 01 025	<b>24024</b>
1"	16	33 01 032	<b>24025</b>
1¼"	16	33 01 040	<b>24026</b>
1½"	16	33 01 050	<b>24027</b>
2"	16	33 01 063	<b>24028</b>

L	Z	E
57	16	55
80	18	65
91	24	80
107	28	81
124	32	113

**PP-P. 01. CPFT - PP COMPRESSION ELBOW**

- 90° elbow**  
• Comp x NPT female thread  
• CTS Standard

- Codo 90°**  
• Comp x rosca hembra NPT  
• CTS Standard

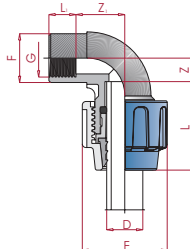

D x G	PN	REF.	CODE
¾"x¾"	10	33 01 425	<b>24029</b>
1"x¾"	10	33 01 431	<b>24034</b>
1"x1"	10	33 01 432	<b>24030</b>
1¼"x1¼"	10	33 01 440	<b>24031</b>
1¼"x1½"	10	33 01 441	<b>24433</b>
1½"x1½"	10	33 01 450	<b>24032</b>
1½"x2"	10	33 01 451	<b>24434</b>
2"x2"	10	33 01 463	<b>24033</b>

L	L <sub>1</sub>	Z	Z <sub>1</sub>	E	F
57	19	16	31	55	34
80	19	18	43	65	34
80	22	18	43	65	41
91	24	24	54	80	52
91	24	24	54	80	60
107	24	28	57	91	60
107	28	28	57	91	75
124	28	32	66	113	75

**TEES**  
**TÉS**

**PP-P. 03. CP - PP COMPRESSION TEE**

- 90° tee**  
• Comp x Comp x Comp  
• CTS Standard

- Té 90°**  
• Comp x Comp x Comp  
• CTS Standard

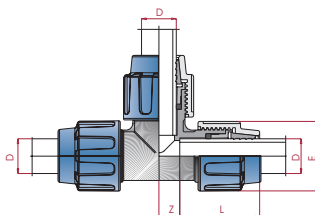

D	PN	REF.	CODE
¾"	16	33 03 025	<b>24007</b>
1"	16	33 03 032	<b>24008</b>
1¼"	16	33 03 040	<b>24009</b>
1½"	16	33 03 050	<b>24010</b>
2"	16	33 03 063	<b>24011</b>

L	Z	E
57	13	55
80	16	65
91	18	80
107	24	91
124	28	113



**PP-P. 03. CPFT - PP COMPRESSION TEE**
**90° tee**

- Comp x NPT female thread x Comp
- CTS Standard

**Té 90°**

- Comp x rosca hembra NPT x Comp
- CTS Standard

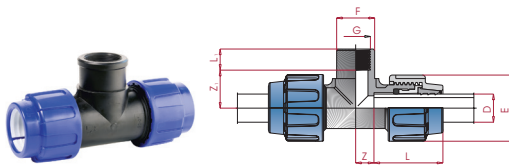

D x G x D	PN	REF.	CODE
¾" x ¾"	10	33 03 425	<b>24012</b>
1" x ¾"	10	33 03 431	<b>24017</b>
1" x 1"	10	33 03 432	<b>24013</b>
1¼" x ¾"	10	33 03 438	<b>24018</b>
1¼" x 1"	10	33 03 439	<b>24019</b>
1¼" x 1¼"	10	33 03 440	<b>24014</b>
1½" x ¾"	10	33 03 447	<b>24020</b>
1½" x 1"	10	33 03 448	<b>24021</b>
1½" x 1½"	10	33 03 450	<b>24015</b>
1½" x 2"	10	33 03 451	<b>24435</b>
2" x ¾"	10	33 03 459	<b>24022</b>
2" x 1"	10	33 03 460	<b>24023</b>
2" x 2"	10	33 03 463	<b>24016</b>

L	L <sub>1</sub>	Z	Z <sub>1</sub>	E	F
49	19	13	26	46	34
57	16	16	31	55	27
80	22	18	43	65	41
-	-	-	-	-	-
-	-	-	-	-	-
91	24	24	54	80	52
-	-	-	-	-	-
-	-	-	-	-	-
107	24	28	57	91	60
139	28	28	57	90	75
-	-	-	-	-	-
-	-	-	-	-	-
124	28	32	66	113	75

**PP-P. 04. CPR - PP COMPRESSION TEE**
**90° reducing tee**

- Comp x Comp x Comp
- CTS Standard

**Té reducida 90°**

- Comp x Comp x Comp
- CTS Standard

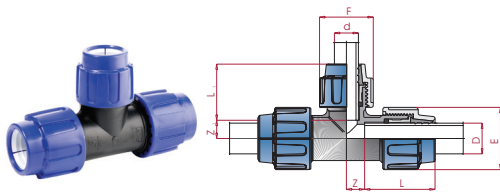

D x d x D	PN	REF.	CODE
1" x ¾"	16	33 04 032	<b>24436</b>
1¼" x 1"	16	33 04 040	<b>24437</b>
1½" x 1¼"	16	33 04 050	<b>24438</b>
2" x 1¼"	16	33 04 062	<b>24439</b>
2" x 1½"	16	33 04 063	<b>24440</b>

L	L <sub>1</sub>	Z	Z <sub>1</sub>	E	F
80	57	18	16	65	55
91	80	24	18	80	65
107	91	28	24	91	80
-	-	-	-	-	-
124	107	32	28	113	91

**COUPLINGS  
ENLACES**
**PP-P. 05. CP - PP COMPRESSION COUPLING**
**Coupling**

- Comp x Comp
- CTS Standard

**Manguito**

- Comp x Comp
- CTS Standard

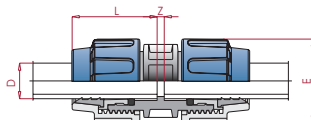

D	PN	REF.	CODE
¾"	16	33 05 025	<b>23986</b>
1"	16	33 05 032	<b>23987</b>
1¼"	16	33 05 040	<b>23988</b>
1½"	16	33 05 050	<b>23989</b>
2"	16	33 05 063	<b>23990</b>

L	Z	E
57	4	55
80	4	65
81	5	80
107	8	91
124	8	113

### PP-P. 05. CPFT - PP COMPRESSION ADAPTOR

**Adaptor**

- Comp x NPT female thread
- CTS Standard

**Enlace**

- Comp x rosca hembra NPT
- CTS Standard

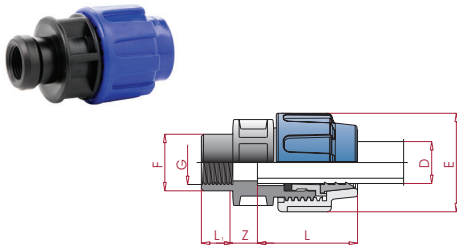

D x G	PN	REF.	CODE
¾"x¾"	10	33 05 425	<b>24036</b>
¾"x1"	10	33 05 426	<b>24442</b>
1"x¾"	10	33 05 431	<b>24042</b>
1"x1"	10	33 05 432	<b>24037</b>
1¼"x1"	10	33 05 439	<b>24035</b>
1¼"x1¼"	10	33 05 440	<b>24038</b>
1½"x1¼"	10	33 05 449	<b>24044</b>
1½"x1½"	10	33 05 450	<b>24039</b>
1½"x2"	10	33 05 451	<b>24443</b>
2"x1½"	10	33 05 462	<b>24045</b>
2"x2"	10	33 05 463	<b>24040</b>

L	L <sub>1</sub>	Z	E	F
57	19	12	55	34
53	22	12	55	41
80	19	15	65	34
80	22	15	65	41
91	22	17	80	41
91	24	17	80	52
107	24	17	91	52
107	24	17	91	60
107	28	17	91	75
-	-	-	-	-
124	28	19	113	75

### PP-P. 05. CPMT - PP COMPRESSION ADAPTOR

**Adaptor**

- Comp x NPT male thread
- CTS Standard

**Enlace**

- Comp x rosca macho NPT
- CTS Standard

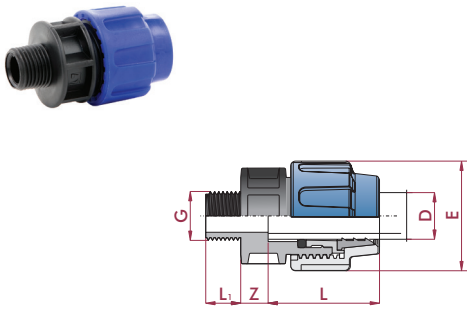

D x G	PN	REF.	CODE
¾"x¾"	10	33 05 625	<b>23445</b>
¾"x1"	10	33 05 626	<b>24444</b>
1"x¾"	10	33 05 631	<b>24445</b>
1"x1"	10	33 05 632	<b>23996</b>
1"x1¼"	10	33 05 638	<b>24446</b>
1¼"x1¼"	10	33 05 639	<b>24447</b>
1¼"x1½"	10	33 05 640	<b>23997</b>
1½"x1¼"	10	33 05 649	<b>24448</b>
1½"x1½"	10	33 05 650	<b>24449</b>
1½"x2"	10	33 05 651	<b>24450</b>
2"x1½"	10	33 05 662	<b>24451</b>
2"x2"	10	33 05 663	<b>24452</b>

L	L <sub>1</sub>	Z	E
57	16	15	55
57	19	15	55
80	16	16	65
80	19	16	65
80	21	16	65
91	21	22	80
91	21	22	80
107	21	23	91
107	21	23	91
107	26	23	91
124	21	25	113
124	26	25	113

### PP-P. 06. CPR - PP COMPRESSION REDUCTION

**Reducing coupling**

- Comp x Comp
- CTS Standard

**Manguito reducido**

- Comp x Comp
- CTS Standard

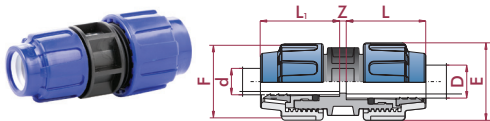

D x d	PN	REF.	CODE
1"x¾"	16	33 06 032	<b>23991</b>
1¼"x1"	16	33 06 040	<b>23992</b>
1½"x1¼"	16	33 06 050	<b>23993</b>
2"x1½"	16	33 06 063	<b>23994</b>

L	L <sub>1</sub>	Z	E	F
80	57	4	65	55
91	80	4	80	65
107	91	5	91	80
124	107	8	113	91

## ELBOWS CODOS

### PP-P. 01. CP - PP COMPRESSION ELBOW

#### 90° elbow

- Comp x Comp
- IPS Standard

#### Codo 90°

- Comp x Comp
- IPS Standard

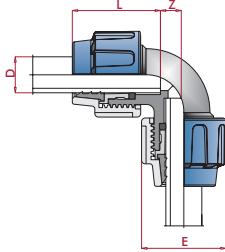

D	PN	REF.	CODE
3/8"	16	66 01 016	<b>21807</b>
1/2"	16	66 01 020	<b>21808</b>
3/4"	16	66 01 025	<b>21809</b>
1"	16	66 01 032	<b>21810</b>
1 1/4"	16	66 01 040	<b>21811</b>
1 1/2"	16	66 01 050	<b>21812</b>
2"	16	66 01 063	<b>21813</b>
3"	10	66 01 090	<b>26777</b>
4"	10	66 01 110	<b>28117</b>

L	Z	E
49	13	46
49	13	46
57	16	55
80	18	65
91	24	80
107	28	81
124	32	113
139	37	127
154	53	151

### PP-P. 01. CPFT - PP COMPRESSION ELBOW

#### 90° elbow

- Comp x NPT female thread
- IPS Standard

#### Codo 90°

- Comp x rosca hembra NPT
- IPS Standard

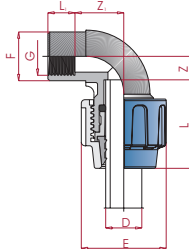

D x G	PN	REF.	CODE
3/8"x1/2"	10	66 01 417	<b>21816</b>
1/2"x1/2"	10	66 01 420	<b>21817</b>
1/2"x3/4"	10	66 01 421	<b>21818</b>
3/4"x1/2"	10	66 01 424	<b>21819</b>
3/4"x3/4"	10	66 01 425	<b>21820</b>
1"x1/2"	10	66 01 430	<b>21821</b>
1"x3/4"	10	66 01 431	<b>21822</b>
1"x1"	10	66 01 432	<b>21823</b>
1 1/4"x1 1/4"	10	66 01 440	<b>21824</b>
1 1/4"x1 1/2"	10	66 01 441	<b>21825</b>
1 1/2"x1 1/2"	10	66 01 450	<b>21826</b>
1 1/2"x2"	10	66 01 451	<b>21827</b>
2"x2"	10	66 01 463	<b>21828</b>
3"x3"	10	66 01 490	<b>26785</b>

L	L <sub>1</sub>	Z	Z <sub>1</sub>	E	F
49	16	13	22	46	27
49	16	13	26	46	27
49	19	13	26	46	34
57	19	16	31	55	34
57	19	16	31	55	34
80	16	18	43	65	27
80	19	18	43	65	34
80	22	18	43	65	41
91	24	24	54	80	52
91	24	24	54	80	60
107	24	28	57	91	60
107	28	28	57	91	75
124	28	31	66	113	75
139	28	41	82	127	75

### PP-P. 01. CPMT - PP COMPRESSION ELBOW

#### 90° elbow

- Comp x NPT male thread
- IPS Standard

#### Codo 90°

- Comp x rosca macho NPT
- IPS Standard

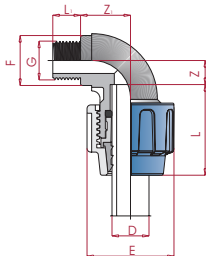

D x G	PN	REF.	CODE
3/8"x3/8"	10	66 01 616	<b>21831</b>
3/8"x1/2"	10	66 01 617	<b>21832</b>
1/2"x1/2"	10	66 01 620	<b>21833</b>
1/2"x3/4"	10	66 01 621	<b>21834</b>
3/4"x1/2"	10	66 01 624	<b>21835</b>
3/4"x3/4"	10	66 01 625	<b>21836</b>
1"x1"	10	66 01 632	<b>21837</b>
1 1/4"x1 1/4"	10	66 01 640	<b>21838</b>
1 1/4"x1 1/2"	10	66 01 641	<b>21839</b>
1 1/2"x1 1/4"	10	66 01 649	<b>21840</b>
1 1/2"x1 1/2"	10	66 01 650	<b>21841</b>
1 1/2"x2"	10	66 01 651	<b>21842</b>
2"x2"	10	66 01 663	<b>21843</b>
2 1/2"x2 1/2"	10	66 01 675	<b>21844</b>

L	L <sub>1</sub>	Z	Z <sub>1</sub>	E	F
49	13	13	27	46	27
49	13	13	27	46	27
49	14	13	26	46	27
49	16	13	26	46	30
57	14	16	34	55	27
57	16	16	34	55	30
80	19	18	45	65	36
91	21	24	58	80	47
91	21	24	58	80	52
107	21	28	67	91	47
107	21	28	67	91	52
107	26	28	67	91	65
124	26	32	77	113	65
139	30	41	82	127	81

### PP-P. 01. CPW - PP COMPRESSION ELBOW

**90° elbow**

- Comp x NPT female thread - wall
- IPS Standard



**Codo 90°**

- De pared - Comp x rosca hembra NPT
- IPS Standard

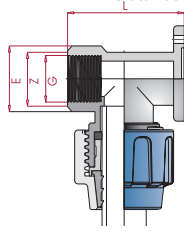

D x G	PN	REF.	CODE
3/4" x 3/4"	10	66 01 225	<b>21845</b>

L	Z	E
65	32	36

### TEES TÉS

### PP-P. 03. CP - PP COMPRESSION TEE

**90° tee**

- Comp x Comp x Comp
- IPS Standard



**Té 90°**

- Comp x Comp x Comp
- IPS Standard

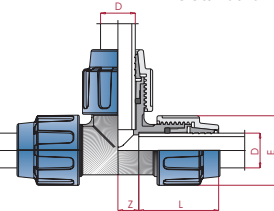

D	PN	REF.	CODE
1/2"	16	66 03 020	<b>21887</b>
3/4"	16	66 03 025	<b>22211</b>
1"	16	66 03 032	<b>21888</b>
1 1/4"	16	66 03 040	<b>21889</b>
1 1/2"	16	66 03 050	<b>21890</b>
2"	16	66 03 063	<b>21891</b>
3"	10	66 03 090	<b>26786</b>
4"	10	66 03 110	<b>28118</b>

L	Z	E
49	13	46
57	13	55
80	16	65
91	18	80
107	24	91
124	28	113
139	32	127
154	41	151

### PP-P. 03. CPFT - PP COMPRESSION TEE

**90° tee**

- Comp x NPT female thread x Comp
- IPS Standard



**Té 90°**

- Comp x rosca hembra NPT x Comp
- IPS Standard

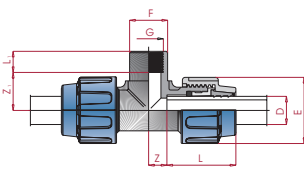

D x G x D	PN	REF.	CODE
1/2" x 1/2"	10	66 03 420	<b>21902</b>
1/2" x 3/4"	10	66 03 421	<b>21903</b>
3/4" x 1/2"	10	66 03 424	<b>21904</b>
3/4" x 3/4"	10	66 03 425	<b>21905</b>
1" x 1/2"	10	66 03 430	<b>21906</b>
1" x 3/4"	10	66 03 431	<b>21907</b>
1" x 1"	10	66 03 432	<b>21908</b>
1 1/4" x 1 1/4"	10	66 03 440	<b>21909</b>
1 1/2" x 1 1/2"	10	66 03 450	<b>21910</b>
1 1/2" x 2"	10	66 03 451	<b>21911</b>
2" x 2"	10	66 03 463	<b>21912</b>
3" x 3"	10	66 03 490	<b>26789</b>
4" x 4"	10	66 03 510	<b>28120</b>

L	L <sub>1</sub>	Z	Z <sub>1</sub>	E	F
49	16	13	22	46	27
49	16	13	26	46	27
57	16	16	31	55	27
49	19	13	26	46	34
57	16	16	31	55	27
57	19	19	31	55	34
80	22	18	43	65	41
91	24	24	54	80	52
107	24	28	57	91	60
139	28	28	57	91	75
124	28	32	66	113	75
154	35	53	55	151	108
174	40	62	60	180	113

**PP-P. 03. CPMT - PP COMPRESSION TEE**
**90° tee**

- Comp x NPT male thread x Comp
- IPS Standard

**Té 90°**

- Comp x rosca macho NPT x Comp
- IPS Standard

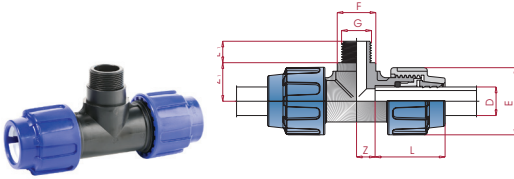

D x G x D	PN	REF.	CODE
1/2"x1/2"	10	66 03 620	<b>21916</b>
1/2"x3/4"	10	66 03 621	<b>21917</b>
3/4"x1/2"	10	66 03 624	<b>21918</b>
3/4"x3/4"	10	66 03 625	<b>21919</b>
1"x1/2"	10	66 03 630	<b>21920</b>
1"x1"	10	66 03 632	<b>21921</b>
1 1/4"x1 1/4"	10	66 03 640	<b>21922</b>
1 1/2"x1 1/2"	10	66 03 650	<b>21846</b>
1 1/2"x2"	10	66 03 651	<b>24458</b>
2"x2"	10	66 03 663	<b>21847</b>

L	L <sub>1</sub>	Z	Z <sub>1</sub>	E	F
49	14	13	26	46	27
49	16	13	26	46	30
57	14	16	34	55	27
57	16	16	34	55	30
57	14	16	34	55	27
80	19	18	45	65	36
99	21	24	58	80	47
107	21	28	67	91	52
-	-	-	-	-	-
124	26	32	77	113	65

**PP-P. 04. CPR - PP COMPRESSION TEE**
**90° reducing tee**

- Comp x Comp x Comp
- IPS Standard

**Té reducida 90°**

- Comp x Comp x Comp
- IPS Standard

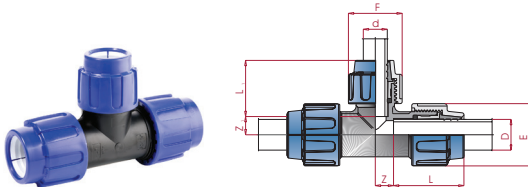

D x d x D	PN	REF.	CODE
3/4"x1/2"	16	66 04 025	<b>21894</b>
1"x3/4"	16	66 04 032	<b>21895</b>
1 1/4"x1"	16	66 04 040	<b>21896</b>
1 1/2"x1 1/4"	16	66 04 050	<b>21897</b>
2"x1 1/4"	16	66 04 062	<b>24110</b>
2"x1 1/2"	16	66 04 063	<b>21898</b>
3"x2"	10	66 04 089	<b>24109</b>

L	L <sub>1</sub>	Z	Z <sub>1</sub>	E	F
57	49	16	13	55	46
80	57	18	16	65	55
91	80	24	18	80	65
107	91	28	24	91	80
-	-	-	-	-	-
124	107	32	28	113	91
139	124	41	31	127	113

**COUPLINGS  
ENLACES**
**PP-P. 05. CP - PP COMPRESSION COUPLING**
**Coupling**

- Comp x Comp
- IPS Standard

**Manguito**

- Comp x Comp
- IPS Standard

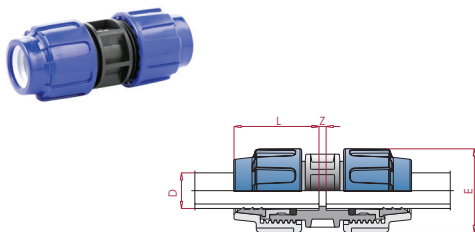

D	PN	REF.	CODE
1/2"	16	66 05 020	<b>21850</b>
3/4"	16	66 05 025	<b>21851</b>
1"	16	66 05 032	<b>21852</b>
1 1/4"	16	66 05 040	<b>21853</b>
1 1/2"	16	66 05 050	<b>21854</b>
2"	16	66 05 063	<b>21855</b>
3"	10	66 05 090	<b>26793</b>
4"	10	66 05 110	<b>28116</b>

L	Z	E
49	4	46
57	4	55
80	4	65
81	5	80
107	8	91
124	8	113
139	10	127
146	10	151

**PP-P. 06. CPR - PP COMPRESSION REDUCTION**
**Reducing coupling**

- Comp x Comp
- IPS Standard

**Manguito reducido**

- Comp x Comp
- IPS Standard

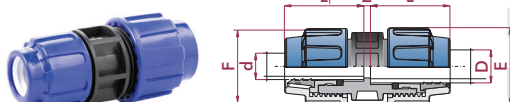

D x d	DN	PN	REF.	CODE
3/4"x1/2"	15	16	66 06 025	<b>21858</b>
1"x3/4"	20	16	66 06 032	<b>21859</b>
1 1/4"x1"	25	16	66 06 040	<b>21860</b>
1 1/2"x1 1/4"	32	16	66 06 050	<b>21861</b>
2"x1 1/2"	40	16	66 06 063	<b>21862</b>

L	L <sub>1</sub>	Z	E	F
57	49	4	55	46
80	57	4	65	55
91	80	4	80	65
107	91	5	91	80
124	107	8	113	91

### PP-P. 05. CPFT - PP COMPRESSION ADAPTOR

**Adaptor**

- Comp x NPT female thread
- IPS Standard

**Enlace**

- Comp x rosca hembra NPT
- IPS Standard

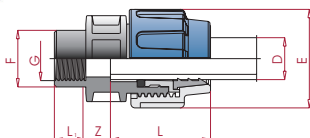

D x G	PN	REF.	CODE	L	L <sub>1</sub>	Z	E	F
½"x½"	10	66 05 420	<b>21866</b>	49	16	11	46	27
½"x¾"	10	66 05 421	<b>21867</b>	49	19	11	46	34
¾"x½"	10	66 05 424	<b>21868</b>	57	16	12	55	27
¾"x¾"	10	66 05 425	<b>21869</b>	57	19	12	55	34
¾"x1"	10	66 05 426	<b>21870</b>	53	22	12	55	41
1"x¾"	10	66 05 431	<b>21871</b>	80	19	15	65	34
1"x1"	10	66 05 432	<b>21872</b>	80	22	15	65	41
1¼"x1"	10	66 05 439	<b>21873</b>	91	22	17	80	41
1¼"x1¼"	10	66 05 440	<b>21874</b>	91	24	17	80	52
1½"x1¼"	10	66 05 449	<b>21875</b>	107	24	17	91	52
1½"x1½"	10	66 05 450	<b>21876</b>	107	24	17	91	60
1½"x2"	10	66 05 451	<b>21877</b>	107	28	17	91	75
2"x2"	10	66 05 463	<b>21878</b>	124	28	19	113	75
3"x3"	10	66 05 490	<b>26795</b>	139	33	39	127	112

### PP-P. 05. CPMT - PP COMPRESSION ADAPTOR

**Adaptor**

- Comp x NPT male thread
- IPS Standard

**Enlace**

- Comp x rosca macho NPT
- IPS Standard

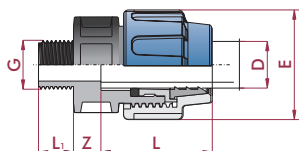

D x G	PN	REF.	CODE	L	L <sub>1</sub>	Z	E
½"x½"	10	66 05 620	<b>21883</b>	49	14	14	46
½"x¾"	10	66 05 621	<b>21884</b>	49	16	14	46
½"x1"	10	66 05 622	<b>21924</b>	49	19	14	46
¾"x½"	10	66 05 624	<b>21925</b>	57	14	15	55
¾"x¾"	10	66 05 625	<b>21926</b>	57	16	15	55
¾"x1"	10	66 05 626	<b>21927</b>	57	19	15	55
1"x¾"	10	66 05 631	<b>21928</b>	80	16	16	65
1"x1"	10	66 05 632	<b>21929</b>	80	19	16	65
1"x1¼"	10	66 05 633	<b>21930</b>	80	21	16	65
1¼"x1¼"	10	66 05 640	<b>21931</b>	91	21	22	80
1¼"x1½"	10	66 05 641	<b>21932</b>	91	21	22	80
1½"x1¼"	10	66 05 649	<b>21933</b>	107	21	23	91
1½"x1½"	10	66 05 650	<b>21934</b>	107	21	23	91
1½"x2"	10	66 05 651	<b>21935</b>	107	26	23	91
2"x1½"	10	66 05 662	<b>21936</b>	124	21	25	113
2"x2"	10	66 05 663	<b>21937</b>	124	26	25	113
3"x3"	10	66 05 690	<b>26797</b>	139	33	39	127
4"x4"	10	66 05 710	<b>28119</b>	146	39	29	151

## CAPS TAPONES

### PP-P. 07. CP - PP COMPRESSION CAP

**Cap**

- Comp
- IPS Standard

**Tapón**

- Comp
- IPS Standard

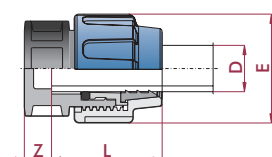

D	PN	REF.	CODE	L	Z	E
½"	16	66 07 020	<b>21942</b>	49	14	46
¾"	16	66 07 025	<b>22212</b>	57	15	55
1"	16	66 07 032	<b>21943</b>	80	16	65
1¼"	16	66 07 040	<b>21944</b>	91	22	80
1½"	16	66 07 050	<b>21945</b>	107	23	91
2"	16	66 07 063	<b>21946</b>	124	25	113